

SH09 SERVICE NOTES

SPECIFICATIONS

Keyboard ----- 32-key, F3-C6(8')	Jacks
Portamento ----- 0-5 s	Signal output -- -10 dBm
Tune range ----- ±65-cent	Phones ----- Stereo 8-ohm
VCF	cv output ----- 1 v/oct
Cutoff frequency -- 10 Hz-20 kHz	Gate output ---- Off:0 v: On:+14 v
Resonance ----- 0-oscillation	CV input ----- 1 v/oct
Envelope generator	Gate input ---- Threshold: +7.5 v
Attack time ----- 1 x3-2.5 s	Ext. sig. input- 0.5 vpp or less
Decay time ----- 2 ms-10 s	Power consumption -- 8-watt
Sustain level ---- 0-100 %	Weight ----- 6.1 kg
Release time ---- 2 ms-10 s	Dimensions
Modulator	605 (w) x 305 (d) x 100 (h) mm
Rate ----- 0.2 Hz-25 Hz	
Delay time ----- 0-1.5 s	

Button no.8
gray
(016-008)

Knob no.57
(016-057)

Knob no.33
(016-033)

Panel H44
(072H044)

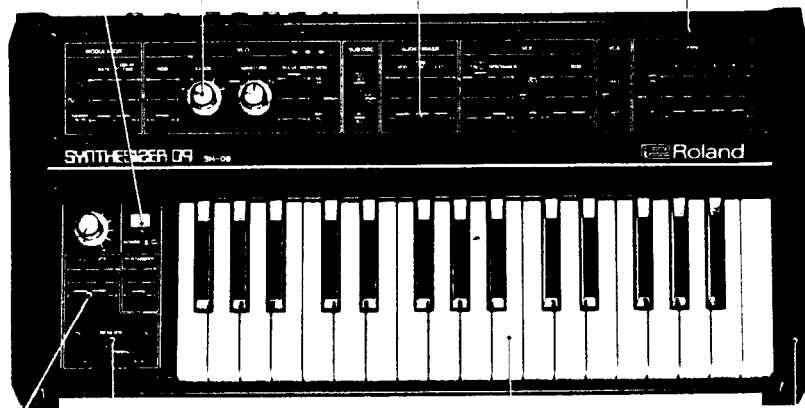

Endblock Bender unit Keyboard X132-F Side panel H21
H22(066H022) PS-4 (029-022) (004-014) R-L set (066H21)

Panel H44 removal screws: (1). (2)

'Tap tight binding head
3 x 10 mm Fe, Br

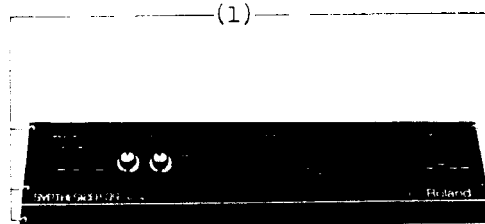

Suffix letter to part number
when ordering pc board.

Jack SG7713 no.4 stereo
(009-036)

Self tapping binding head
3 x 6 mm Bl, Fe, Br

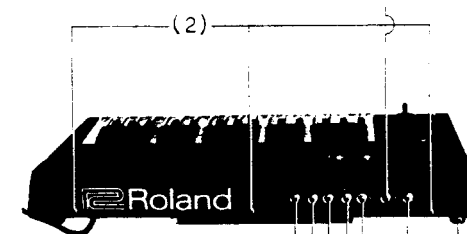

Jack SG7622 no.8
(009-012)

Rubber foot
G-5 (111-021)
G-7 front, not shown
(111-023)

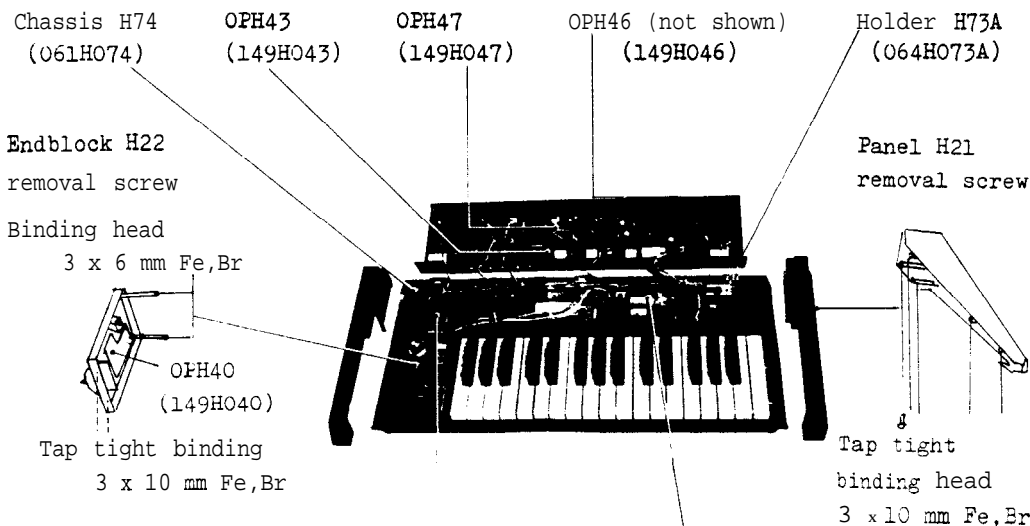

Power transformer	Power supply board
H20J (022H020J) 100 v	PSH31 (146H031) 100 v
H20C-B (022H020C-B) 117 v	PSH32 (146H032) 117 v
H20D (022H020D) 220/240 v	PSH33 (146H033) 220/240 v

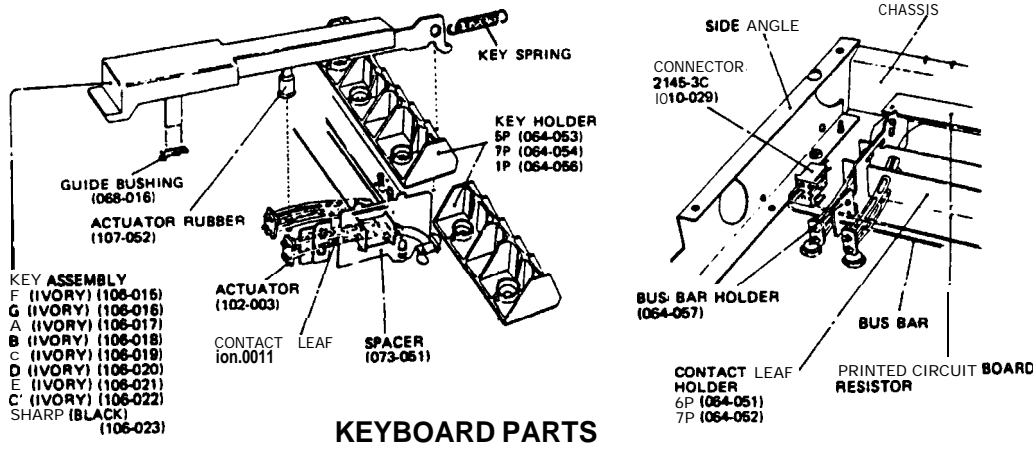

INSTRUMENT MODEL	KEYS	KEYBOARD MODEL	KEY SPRING	BUS BAR	PCB		RESISTOR	
					6 P	7 P		
SH-1	32	SK-132-D	070-052	C71H034	052-066	052-067	100 1/4W +1% CRB1/4FX	
SH-09	32	SK-132-F	identical to SK-132D except for blind					

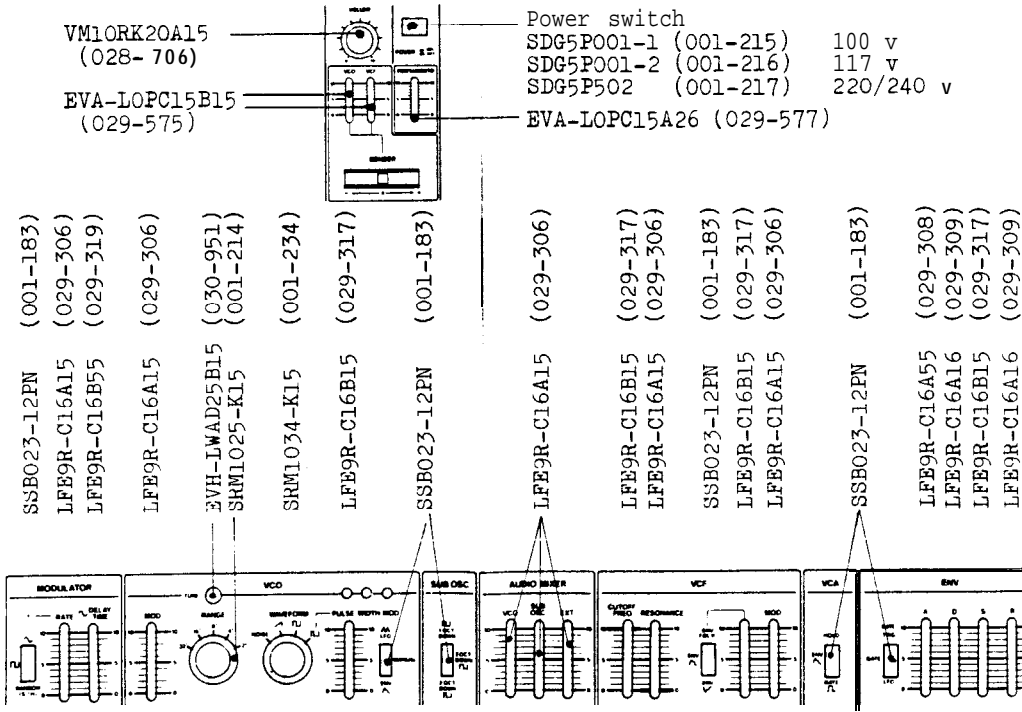

BLOCK DIAGRAM

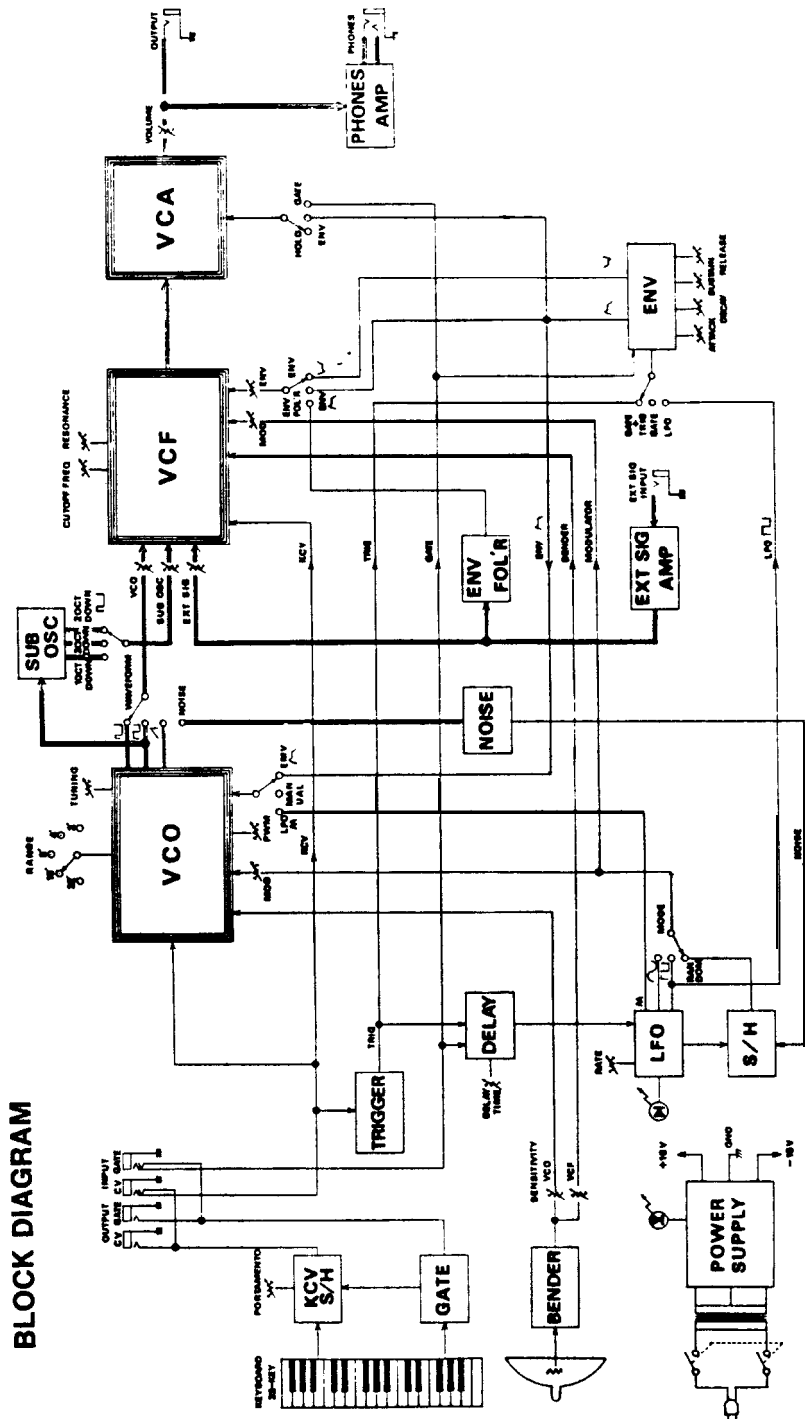

PARTS LIST

072H044 Panel (top) H44
 066H022 Endblock (bender) H22
 066H021 Side panel H21 a pair of R and L
 061H074 Chassis H74
 111-021 Foot G-5 rear
 111-023 Foot G-7 front
 068-020 Bushing no.20 panel

004-014 Keyboard SK132-F
 029-022 Bender assy PB-4
 016-057 Knob no.57 rotary
 016-033 Knob no.33 slider
 063-012 Strip no.12 knob no.33
 016-008 Button no.8 gray, power switch

009-012 Jack SG7622 no.8 mono
 009-036 Jack SG7713 no.4 stereo
 068-005 Bushing no.5 jack
 068-018 Bushing no.18 red, jack

022H020J Power transformer H20J 100 v
 022H020C-B Power transformer H20C-B 117 v
 022H020D Power transformer H20D 220/240 v

SWITCH

001-215 SDG5P001-1 power 100 V
 001-216 SDG5P001-2 power 117 V
 001-217 SDG5P502 power 220/240 V
 001-234 SRM1034-K15 rotary 3p-4t WAVEFORM
 001-214 SRM1025-K15 rotary 2p-5t RANGE
 001-183 SSB023-12FN slide 2p-3t

CAPACITOR

035-156 ECQS1151KZ 150 pF polystyrene
 035-188 ECQS1102KZ 1000 pF polystyrene
 035-091 ECQF-2334M 0.33 mfd polypropylene

PCB ASSEMBLY

149H046C OPH46C (pcb 052H141-2-C)
 149H047C OPH47C (pcb 052H141-1-C)
 149H040B OPH40B (pcb 052H140B)
 149H043B OPH43B (pcb 052H150B)
 146H031A PSH31A (pcb 052H139A) 100 v
 146H032A PSH32A (pcb 052H139A) 117 V
 146H033A PSH33A (pcb 052H139A) 220/240V

SEMICONDUCTOR

IC

020-097 μ PC4558C
 020-100 TLO82CP
 020-039 DN819
 020-032 μ A726HC
 020-160 BA662A

020-189 TA7140P
 020-102 LF13741H
 020-103 TA7179P

TRANSISTOR

017-097 2SA826-Q
 017-118 2SC1740-Q
 017-046 2SC828 NZ (noise generator)
 017-022 2SB434-0
 017-010 2SD234-0
 017-014 2SK30A-Y FET
 017-016 2SK30A-GR FET

DIODE

018-014 132473
 018-078 1S2353 zener
 018-089 1B4B41 rectifier stack
 019-009 LR0601R LED

FUSE. FUSE HOLDER

008-029 MGP 0.25 A prim. 100/117 V
 008-060 SEMKO T250 mA prim. 220/240 V
 008-059 SEMKO T200 mA sec. 220/240 V
 012-003 TF758 fuse clip

POTENTIOMETER

029-306 LFE9RC16A15 100 KA slide
 029-317 LFE9RC16B15 100 KB slide
 029-308 LFE9RC16A55 500 KA slide
 029-319 LFE9RC16B55 500 KB slide
 029-309 LFE9RC16A16 1 MA slide
 029-575 EVALOPC15B15 100 KB slide
 029-577 EVALOPC15A26 2 MA slide
 028-706 VM10RK20A15 100 KA rotary
 030-951 EVHLWAD25B15 100 KB rotary
 030-641 RJ6-202 2 KB trimmer, metal film
 030-643 RJ6-103 10 KB trimmer, metal film
 030-463 SR19R 4.7 KB trimmer
 030-465 SR19R 10 KB trimmer
 030-469 SR19R 47 KB trimmer
 030-471 SR19R 100 KB trimmer

WAFER TERMINAL. WIRING ASSEMBLY

010-183 5045-03A Terminal 010-186 5045-05A
 010-218 EMCS 0750 010-220 EMCS 0950
 053H034 A Wiring assy
 053H035 B 010-226 EMCB 0730851 7p-30 cm
 053H036 C 010-228 EMCB 0920851 9p-20 cm

OTHERS

064H055A Holder H55A(pot.VOL.bracket)
 064H073A Holder H73A(chassis-top panel)
 064-264 PCB holder DLCBS-4N
 053H030 Flat cable H30
 053H031 Flat cable H31
 053H032 Flat cable H32
 048H001 Heat sink H1

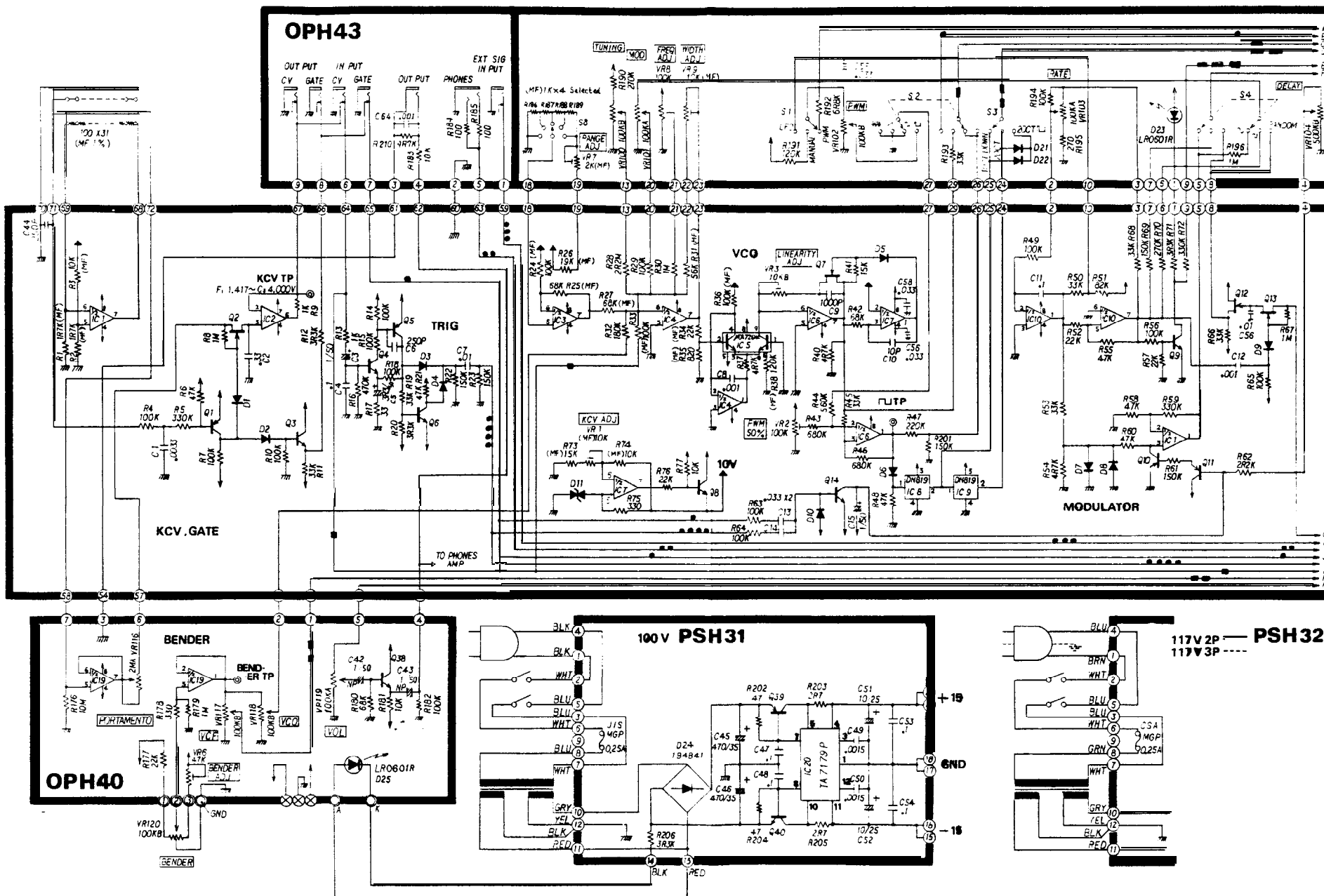

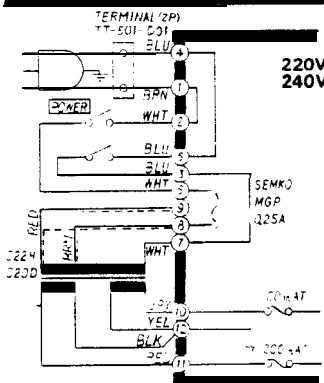
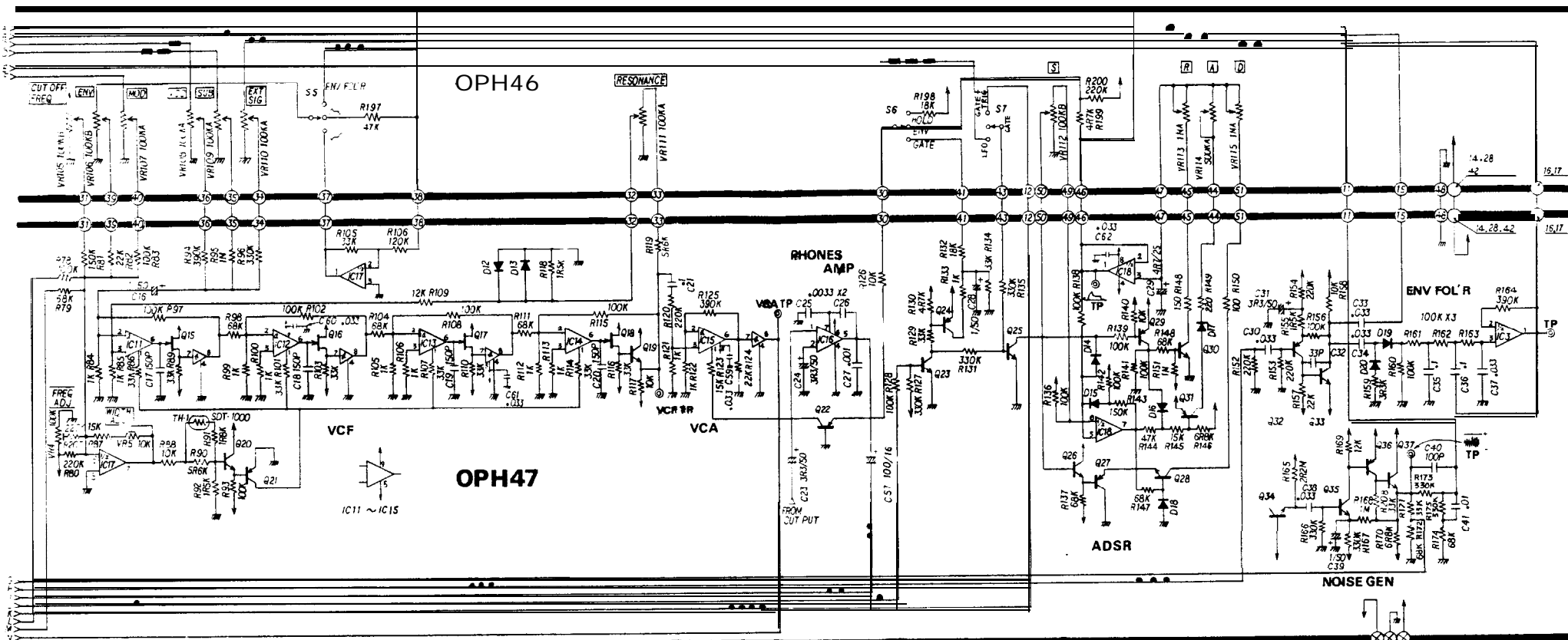

PSH33

- Resistor : 1n ohm (MF-- metal oxide film, 1%)
- Capacitor : 1n microfarad (P-- picofarad)
- Diode : 1S2475 or 1S1555 (D11-- 1S2453)
- IC1, 5-4, 10, : uPC4558C
- IC11-19 : 74LS741H
- IC2 : uA709RC
- IC3, - : TL082
- IC4 : BA662A
- IC11-14 : BA662 A B factory selected
- IC15 : LM1370C
- FET transistor : 2S482e-Q or 2S4733-Q
- WET transistor : 2S6170-Q or 2S6944-Q
- 4-1, 2 : 2SK30A-BR FET
- 211, 21-18 : 2SA 6A-F FET

NOTES -- Replacing Selected IC, Transistor --
When replacing Q12, IC11-14, take the following procedures.

Q12

Choose 2SK30A-Y for minimum leakage.
Check new Q12 for leakage with VCO being LFO modulated under the following settings:
MOD--"10" RATE--"0"
MODULATOR--RANDOM
VCO should not drift before the next d/H pulse generates.

IC11-14

The VCF, being a set of four BA662's of much the same characteristics in transconductance, requires a test of BA662 A/B instock as a replacement.
Solder BA662 tentatively after defective one is removed.
Press C2 key with CUTOFF set at "0" and RESONANCE at "10" -- no input signal.
Approximate 50Hz oscillation at VCF stage proves the IC adequate.

OPH43B 149H043B
(Etch mask 052H150B)

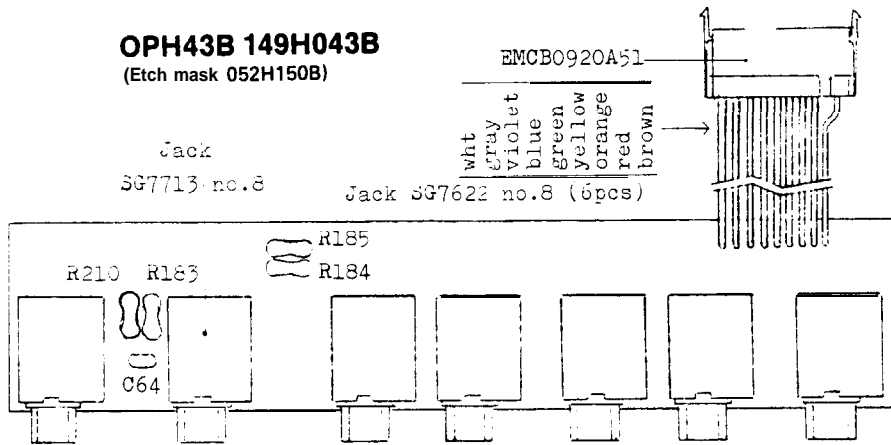

View from the foil side

ADJUSTMENT

KEY DESIGNATION
only for the adjustments

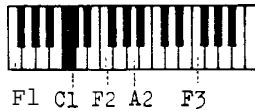

BENDER

Panel setting and connection:
Digital voltmeter! at 10

1. Flip and hold Bender lever at the left (-). Note the reading.
2. Turn and hold the lever at the right (+). Adjust VR-6 on OPH40 for the same reading, but opposite polarity, as in step 1. (Difference between two readings must be within 30 mV.)

KCV

- Connect digital voltmeter to TP-2 on OPH47.
1. Press F1 key and note the reading, (F1-V).
 2. While pressing F3 key, adjust VR-1 on OPH-47 for F1-V + 2.000 V reading.
 3. Since turning VR-1 has an effect on F1-V, repeat steps 1 and 2 until F3-V becomes F1-V + 2.000 V + 1 mV.

SH09

VCO

Set panel controls as illustrated right.

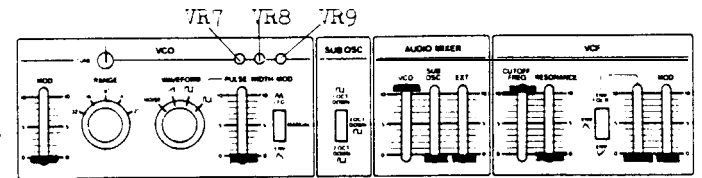

Connect an oscilloscope to TP-3 on OPH47. Apply reference F note to the scope EXT. IN for Lissajous figures.

A) 'WIDTH

- Set RANGE at 8'.
1. With F3 key held down, adjust VR-8 for motionless figures.
 2. While pressing down F1 key, adjust VR-9 for motionless figures. F3 pitch will vary as VR-9 turned.
 3. Repeat steps 1 and 2 until F3 and F1 figures stand still.

B) LINEARITY

- details follow A) WIDTH --
- Set RANGE at 2'.
- Adjust the pots.
1. F1 key --- VR-8.
 2. F3 key --- VR-3.
 3. Repeat steps 1 and 2.

Adjustments A and B must be repeated because of cross interference between them.

C) RANGE

- refer to A)WIDTH for details--
- Set RANGE at 32'.
- Obtain stable Lissajous figures.
1. F1 key --- VR-8.
- Place RANGE at 2'.
- Obtain motionless figures.
1. F1 key --- W-7.

D) FREQUENCY

- Set RANGE at 8'.
- Set TUNE at its midpoint.
1. While playing A2 key, adjust VR-8 for 440 Hz.

E) DUTY CYCLE

- Set WAVEFORM at \square .
1. Adjust VR-2 for 1:1 mark/space.

VCF

Set Controls as shown below.

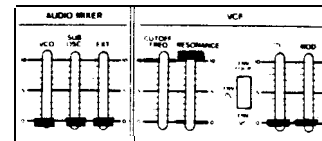

Connect oscilloscope to TP-3 on OPH47.

A) WIDTH

1. While pressing A2 key, set CUTOFF FREQ. for approximate 1 kHz.
2. While playing F2 and F3 keys alternately, turn VR-5 until F3 figure doubles F2 in cycle.

B) FREQUENCY

- Slide up CUTOFF knob to "10".
1. With F1 key held down, set VR-4 for 20 kHz.

- OPH46 OPH47
- 2SK30A
 - 28C1740-Q or 2X945-4
 - 2SA826-Q or 2SA733-Q
 - 152473 or 1S1555
 - Metal oxide film CRB+FX
 - OPH46-- R186-189 : tailored for nearly equal resistance

- ECEA
- Mylar 50V K
- Ceramic 50V K
- Check point 59BS8806
- SR19R
- Metal film RJ6

PSH31A 100V, PSH32A 117V, PSH33A 220/240V
146H-31/32/33-A (Etch mask 052H139A)

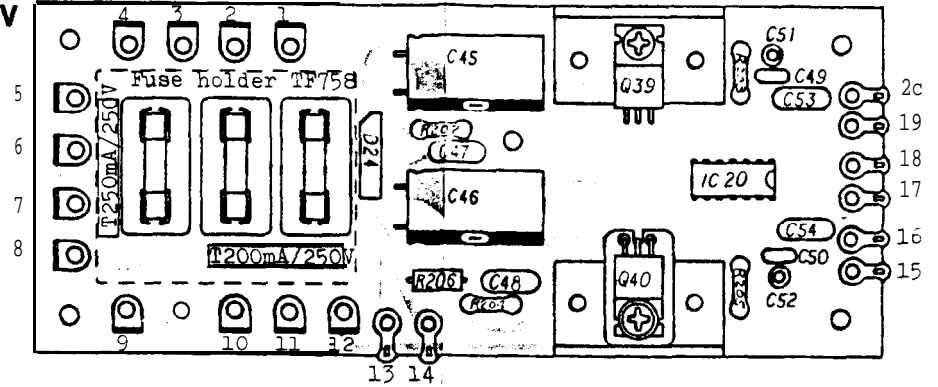
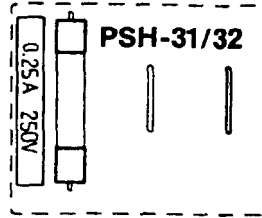

OPH46C(149H046C) View from foil side

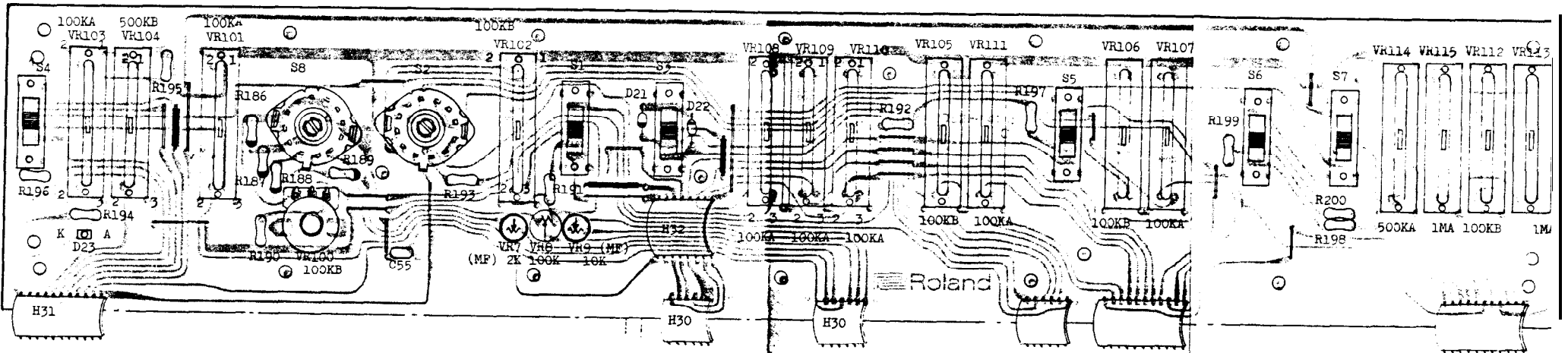

OPH47C(149H047C) (PCB 052H141(1)C)

For selected semiconductors, see NOTES on page 5.

IC11-14: BA662 selected.

